

Promat

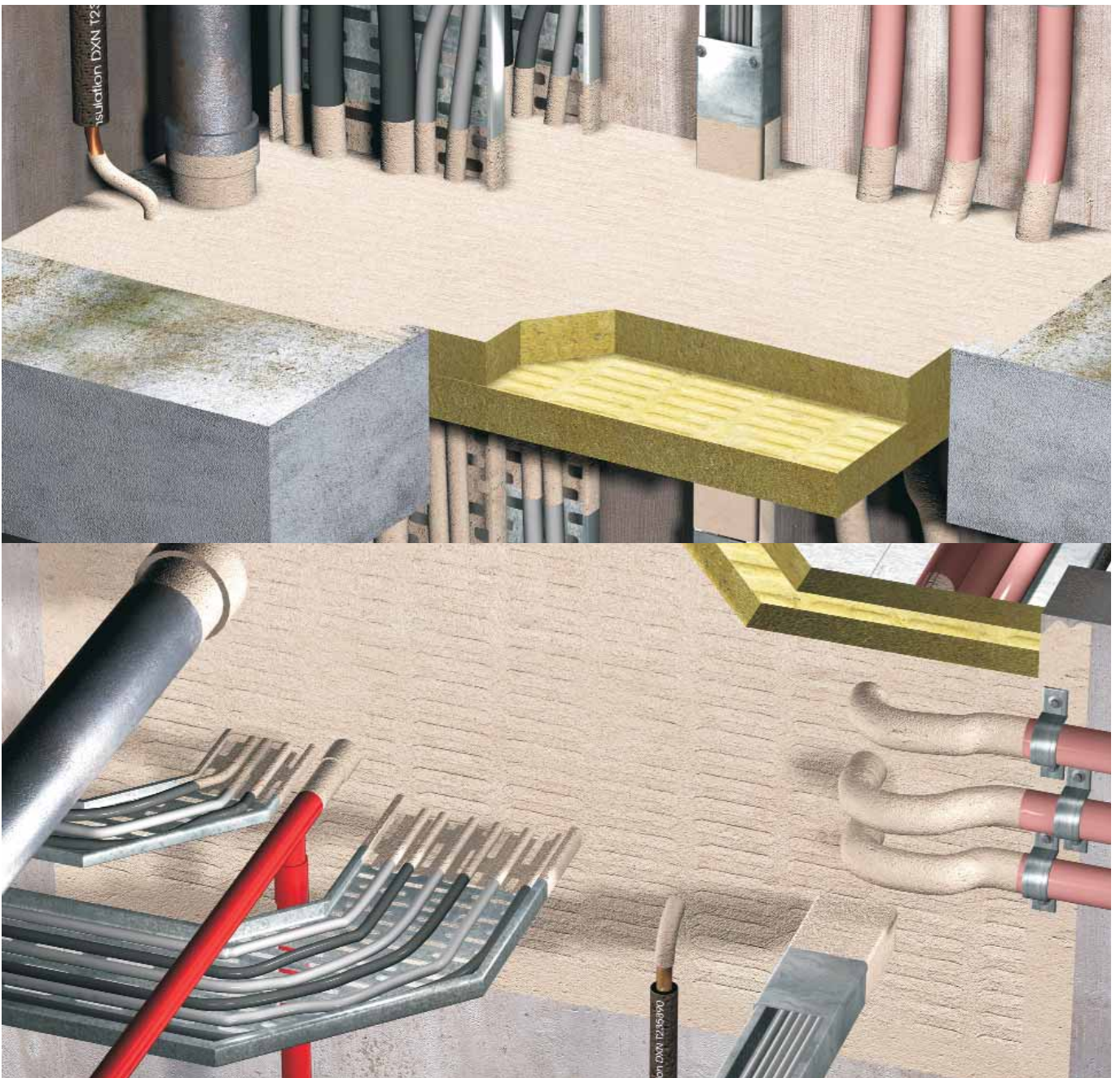

PROMASEAL® Bulkhead Sealer System Penetration Seals on Floors/Slabs/Walls



PROMASEAL® Bulkhead Sealer System is made from high density mineral wool. The mineral wool is coated with PROMASEAL® Bulkhead Sealer, which will remain in place during a fire and form a barrier against fire.

PROMASEAL® Bulkhead Sealer System is the simplest of all fire stopping products to use. It is also one of, if not the most economical product to use. It can be used in wall and floor applications and has been tested for up to 2 hours with various services penetrating the fire-resisting element.

In many buildings, power cables, (such as computer and telecommunication cables) are being continuously added and removed. The PROMASEAL® Bulkhead Sealer System enables this process to be carried out with the minimum amount of mess and inconvenience.

Packaging

Supplied in pre-coated batts measuring 1.2m x 0.6m or 5kg containers of sealer.

Fire Performance

PROMASEAL® Bulkhead Sealer System has been successfully tested in wall and floor constructions for up to 2 hours. Tests were carried out to AS 1530: Part 4: 1997 and BS 476: Part 20: 1987 and achieved a Fire Resistance Level of -/120/120 on the un-penetrated system. Insulation Criteria will vary if measured on service penetrations. For floors a -/120/120 system consist of a double layer of coated batts and a -/120/90 system consists of a single coated batt. For walls two batts are always required.

Function

1. Test Evidence

It is important to be aware of the types of services that will pass through the System. There may be a requirement to produce evidence that it is a tested system. This requirement may vary from country to country depending upon the way test results are interpreted and local regulations are implemented.

The services that have been tested in walls are:

- Cables in bundles and on cable trays.
- Copper pipes up to 150mm diameter. This would normally allow the use of all size pipes up to 150mm for copper, brass and steel. Please check with your local regulations.
- 100m uPVC pipes with PROMASEAL® Wall Collar (FCW). This would allow the use of FCW collars to plastic pipe on sizes up to 100mm.

The services that have been tested in floors are:

- Cables in bundles and on cable trays.
- Cable ducting.
- Steel pipe.

2. Applications

The system is used around services that penetrate walls and floors through oversize openings that are too large to be sealed with PROMASEAL® Acrylic Sealant.

That is, the wall or floor has had an oversize opening left for the service(s) to pass through. All services are then directed through the opening, which has to be reinstated to maintain the fire rating of the wall or floor.

PROMASEAL® Bulkhead Sealer System can be used in power stations and large industrial complexes where many cables (and other services) pass along service tunnels between buildings.

In these "Industrial" areas, Building Codes often do not apply and the installation of fire barriers is enforced because insurance companies have a large financial exposure, not only on the buildings but also the loss of production that could follow a fire that was not confined to one area.

Applications are common in hospitals and universities (in particular, those that have laboratories). Services are usually directed along corridors above ceilings and pass through fire rated barriers above fire doors. It is difficult to reinstate the block work around the services and other barrier systems often prove to be just too awkward to install.

For lightweight fire rated walls, (steel and timber framed) the number of services passing through the opening can mean that the board installer will not be able to reinstate the lining close enough to the services to allow the use of PROMASEAL® Acrylic Sealant by itself. In this type of construction, the PROMASEAL® Bulkhead Sealer System is really the most economical method of sealing the opening.

PROMASEAL® Bulkhead Sealer System is especially useful under computer flooring and between the tops of walls and floor slabs or roofs where services often pass.

Installation

1. Floors

For a double layer system the maximum width of a floor opening is 600mm x unlimited length, supported at 1500mm centres on nominal 50mm x 50mm x 1.2mm steel angles, welded back to back which are supported on all edges on either a concrete ledge (with minimum 20mm bearing) or 20 x 20 x 1.2mm angles bolted to the slab at 600mm centres with 8mm x 40mm steel anchors. Apply a bead of PROMASEAL® Acrylic Sealant between the angle and floor slab to seal and take up any irregularities in the surfaces. Openings 300mm or less can be of unlimited length supported only on the edges as described above.

Where a single batt system is used, support angle should be nominal 50mm x 30mm x 1.2mm. The batts must have no more than a 5mm gap between them at these support angles and fill this gap with PROMASEAL® Acrylic Sealant. The maximum width for a single layer system is 600mm x unlimited length supported as above. Openings 300mm or less need no support at joints. The ends of the batts must be fitted tight together and coated with nominal 2mm of Bulkhead Sealer and an addition strip of 75mm wide Bulkhead System batt should be placed over the join held in place with Bulkhead Sealer.

Additional support is not required to the barrier system.

A two hour (-/120/120) insulated system consists of 2 x 50mm x 120kg coated (each on one face) mineral fibre batts. Each batt is placed in the floor opening with the coated face exposed. 1st Batt coating side facing down. 2nd Batt coating side facing up.

Where the opening is greater than 1500mm long and support angles are used (as described above), do not have an air gap between the two batts. The top most layer should sit on the bottom layer ensuring joints are staggered between the layers.

A two hour (-/120/90) insulated system consists of 1 x 50mm x 120kg (coated on both faces) mineral fibre batt. Each side of the batt is coated with PROMASEAL® Bulkhead Sealer with the top face of the batt positioned flush with the top surface of the floor slab.

Cut the pre-coated batt(s) to fit the opening and around the services.

Before placing the batts in position, apply a thin film (nominal 2mm thick) of PROMASEAL® Bulkhead Sealer over the entire surface of the mating edges of the floor and the Batt.

In the same manner, coat all services that pass through the opening for a distance of 100mm from the face of both sides of the bulkhead batt. Coat the services over the entire length where they pass through the floor.

Wherever it is necessary to cut and butt joint the batts, ensure the cut surfaces are coated in the same way.

NOTE: All joints must be staggered by at least 150mm for double layer systems.

Typical Floor Application

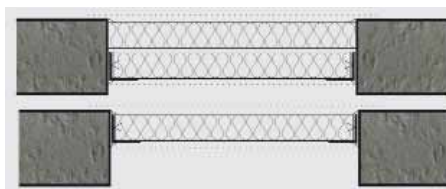

(continued on page 4)

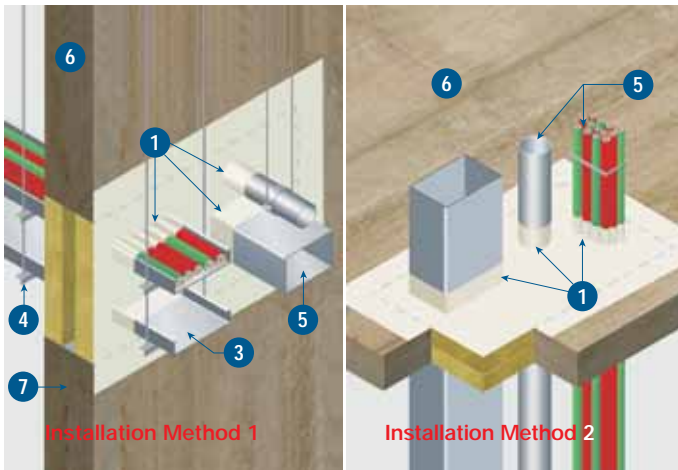

Installation Method 1

Installation Method 2

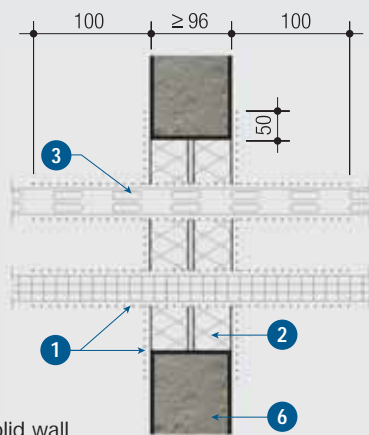

Detail 1 Solid wall

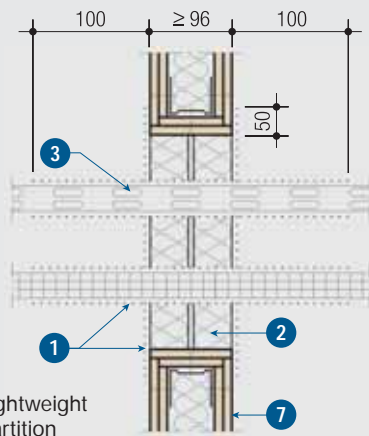

Detail 2 Lightweight partition

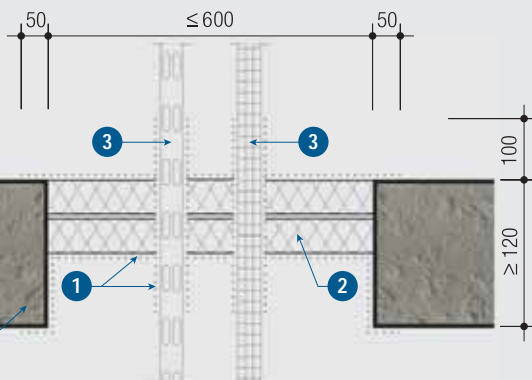

Detail 3 Floor penetration

TECHNICAL DATA

2 hours fire rating, integrity (and insulation on the barrier) in accordance with the criteria of BS 476: Part 20 and AS 1530: Part 4.

- 1 PROMASEAL® Bulkhead Sealer System, 1mm-2mm thick
- 2 Mineral wool panels, 2 x 50mm thick
For -/120/90 or -/120/- a single layer floor system may be installed. See Floor instructions on page 2.
- 3 Cable trays
- 4 Suspension or support of cable trays
- 5 Cables, cable bunches, optical waveguides, metal pipes or service trunking
- 6 Brickwork or concrete walls, with fire resistance ³ the fire resistance of the installed system
- 7 Light weight partitions, with fire resistance \geq the fire resistance of the installed system
- 8 Solid slab, with fire resistance \geq the fire resistance of the installed system

NOTE: Insulation criteria will vary depending upon the system used and the services.

Detail 1 Solid wall

PROMASEAL® Bulkhead Sealer System may be mounted in brickwork, concrete or lightweight walls ≥ 96 mm thick, provided the fire resistance is higher or equal to the installed system.

For installations in thicker walls, the mineral wool panels are arranged as a flush surface on both sides with a suitable gap in between. For cable seals, the cable trays have to be supported on both sides nominal 100mm before the wall opening 4.

Detail 2 Lightweight partition

The lightweight partitions should be tested to either BS 476: Part 22 or AS 1530.4 to the same or greater period of fire resistance as the Bulkhead System.

Detail 3 Floor penetration

Typical arrangement of cable trays within PROMASEAL® Bulkhead Sealing System.

Wall Opening ≤ 1000 mm high with maximum 1m² surface area
 ≤ 500 mm high x unlimited length

Floor Opening ≤ 600 mm wide x unlimited length
when supported every 500mm (maximum)
 ≤ 300 mm wide x unlimited length
unsupported at joints

For more information on application, please check with your local supplier or nearest Promat office.

Installation (continued from page 2)

2. Walls

The maximum size wall opening is 1m² i.e. 1000mm x 1000mm (Maximum dimension in either direction no greater than 1000mm). For openings 500mm high or less the opening length is unlimited so long as the wall is structurally sound.

If the opening is greater than this it should either be reduced using the same construction materials as the wall or install structural elements across the opening to create openings no more than 1m².

Additional support is not required to the barrier system.

In plasterboard and calcium silicate board walls, the opening must be trimmed all round with wall framing sections which must be lined with the board in the same manner as the the face of the wall is lined.

A two hour system consists of 2 x 50mm x 120kg coated (each on one face) mineral fibre batts. Each batt is placed in the wall opening with the coated face exposed and sitting flush with the face of the wall.

Cut the pre-coated batts to fit the opening.

Before placing the batts in position, apply a thin film (nominal 2mm thick) of PROMASEAL® Bulkhead Sealer over the entire surface of the exposed edges of the wall (or wall framing)

In the same manner, coat all services that pass through the opening for a distance of 100mm from the face of both sides of the wall. Coat the services over their entire length where they pass through the wall (cavity) in the same way.

Wherever it is necessary to cut and butt joint the batts, ensure the cut surfaces are coated in the same way.

Double layer application

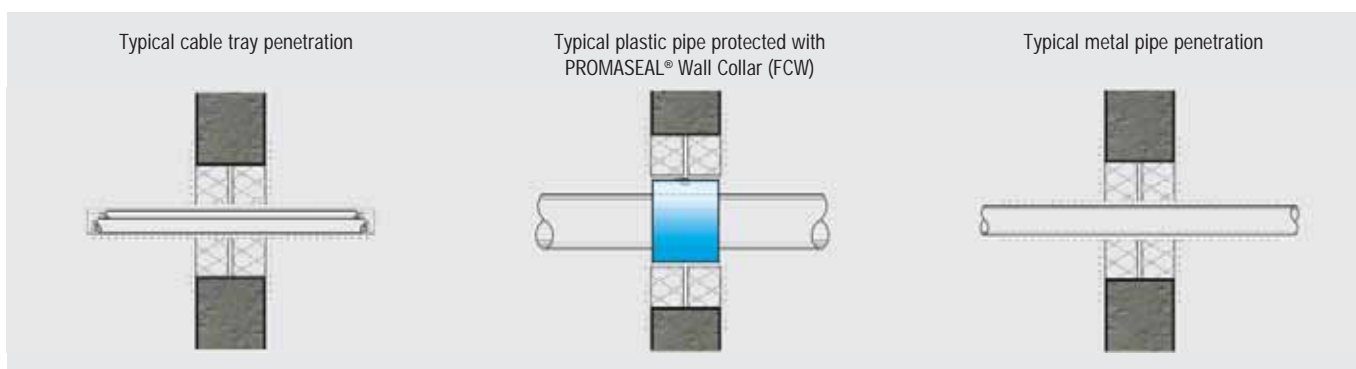

Warning

PROMASEAL® Bulkhead Sealer Systems are Non Load bearing. It is advisable to install a warning sign on all applications:

WARNING, THIS IS A FIRE RATED BARRIER. DO NOT DISTURB. DO NOT WALK OR PLACE ANY LOADS ON OR AGAINST THE BARRIER. IF BARRIER IS DAMAGED CALL PROMAT.

Load bearing systems are available, please contact your local supplier or nearest Promat office.

Specification

All openings (with & without service penetrations) in fire rated walls and floors are to be sealed with PROMASEAL® Bulkhead Sealer System as tested and approved to AS 1530: Part 4: 1997 and BS 476: Part 20: 1987.

The system must be installed in accordance with the manufacturer's instructions and certified in an approved manner.

Important Notes

Promat product data sheets and health and safety data sheets are regularly reviewed and are available on request. The successful use of this system is dependent on a number of factors. As the information contained in this literature can only be of a general nature, it is advisable to consult our technical department if there is any doubt about the correct use of this system in a particular application. Our technical representatives and advisors are available to provide further technical and commercial assistance.

PROMASEAL® Bulkhead Sealer System is manufactured under a quality management system certified in accordance with ISO 9001: 2000. The production unit has passed the site audit of ISO 14001 and all manufacturing processes are in accordance with the environmental standards of ISO 14001.

ASIA PACIFIC HEADQUARTERS

Promat International (Asia Pacific) Ltd.
Tel: +60 (3) 2095 5111
Fax: +60 (3) 2095 6111
Email: info@promat-ap.com

AUSTRALIA

Promat Australia Pty. Ltd.
Tel: +61 1800 30 20 20
Fax: +61 (8) 8352 1014
Email: mail@promat.com.au

**New South Wales Office
Promat Australia Pty. Ltd.**
Tel: +61 1800 30 20 20
Fax: +61 (2) 9630 0258
Email: mail@promat.com.au

**Victoria Office
Promat Australia Pty. Ltd.**
Tel: +61 1800 30 20 20
Fax: +61 (3) 9645 3844
Email: mail@promat.com.au

**Western Australia Office
Promat Australia Pty. Ltd.**
Tel: +61 1800 30 20 20
Fax: +61 1800 33 45 98
Email: mail@promat.com.au

CHINA

Promat China Ltd.
Tel: +86 (20) 8136 1167
Fax: +86 (20) 8136 1372
Email: info@promat.com.cn

**Beijing Office
Promat North China
(Division of Promat China Ltd.)**
Tel: +86 (10) 8589 1254
Fax: +86 (10) 8589 2904
Email: info@promat.com.cn

HONG KONG

Promat International (Asia Pacific) Ltd.
Tel: +852 2836 3692
Fax: +852 2834 4313
Email: apromath@promat.com.hk

INDIA

**Promat International (Asia Pacific) Ltd.
(India Representative Office)**
Tel: +91 (11) 2433 1594
Fax: +91 (11) 2433 1595
Email: info-india@promat-asia.com

MALAYSIA

Promat (Malaysia) Sdn. Bhd.
Tel: +60 (3) 2095 8555
Fax: +60 (3) 2095 2111
Email: info@promat.com.my

SINGAPORE

Promat Building System Pte. Ltd.
Tel: +65 6776 7635
Fax: +65 6776 7624
Email: info@promat.com.sg

VIETNAM

**Promat International (Asia Pacific) Ltd.
(Vietnam Representative Office)**
Tel: +84 (8) 931 5964
Fax: +84 (8) 931 5964
Email: phuong@promat-asia.com

OFFICIAL WEBSITE

www.promat-ap.com

Your local Promat supplier

